

Nano Socket iWiFi™

# Nano Socket iWiFi™

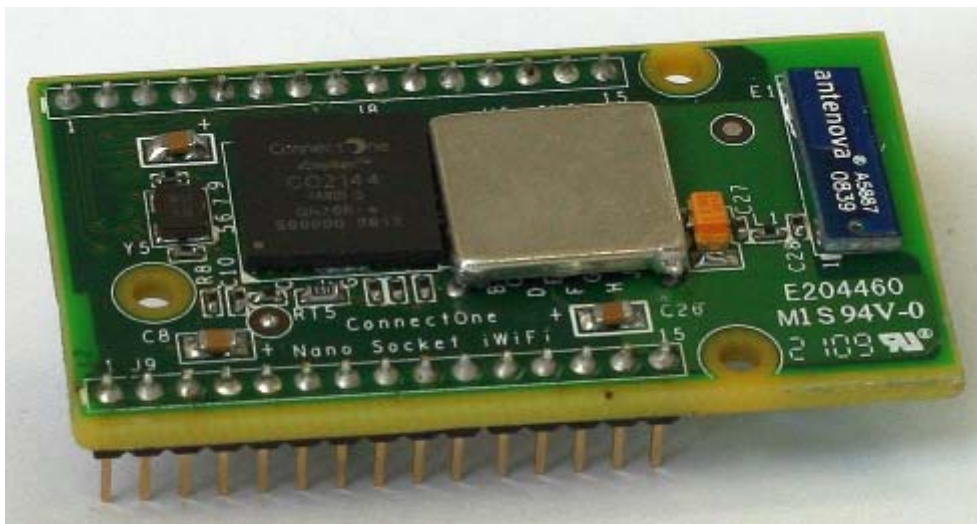

## Data Sheet

Ver. 1.35

**ConnectOne™**

International:  
Connect One Ltd.  
20 Atir Yeda Street  
Kfar Saba 44643, Israel  
Phone: +972-9-766-0456  
Fax: +972-9-766-0461  
Email: [sales@connectone.com](mailto:sales@connectone.com)  
[www.connectone.com](http://www.connectone.com)

USA:  
560 S. Winchester Blvd.  
Suite 500  
San Jose, CA 95128  
Tel: (408) 572-5675  
Fax: (408) 572-5601

Information provided by Connect One Ltd. is believed to be accurate and reliable. However, Connect One assumes no responsibility for its use, nor any infringement of patents or other rights of third parties, which may result from its use. No license is granted by implication or otherwise under any patent rights of Connect One other than for circuitry embodied in Connect One's products. Connect One reserves the right to change circuitry at any time without notice. This document is subject to change without notice.

The software described in this document is furnished under a license agreement and may be used or copied only in accordance with the terms of such a license agreement. It is forbidden by law to copy the software on any medium except as specifically allowed in the license agreement. No part of this document may be reproduced or transmitted in any form or by any means, electronic or mechanical, including but not limited to photocopying, recording, transmitting via fax and/or modem devices, scanning, and/or information storage and retrieval systems for any purpose without the express written consent of Connect One.

**WARNING:** THE Nano Socket iWiFi IS AN RF MODULE INTENDED FOR EMBEDDING IN A HOST DEVICE. LOCAL RELEVANT RF REGULATIONS SUCH AS ALLOWED FREQUENCIES AND USAGE IN COMMERCIAL FLIGHTS MUST BE OBSERVED. SAFETY INSTRUCTIONS MUST BE INCLUDED IN THE MANUALS OF THE HOST DEVICE. CONNECT ONE ASSUMES NO LIABILITY FOR CUSTOMER FAILURE TO COMPLY WITH THESE PRECAUTIONS.

**Modifications**

The FCC requires the user to be notified that any changes or modifications made to this device that are not expressly approved by Option could void the user's authority to operate the equipment.

**This device complies with Part 15 of the FCC rules.**

This device complies with Part 15 of the FCC rules. Operation is subject to the following two conditions:

- (1) this device may not cause harmful interference, and
- (2) this device must accept any interference received, including interference that may cause undesired operation.

**Exposure Information to Radio Frequency Energy**

This equipment complies with FCC radiation exposure limits set forth for an uncontrolled environment. This equipment should be installed and operated with minimum distance of 20 cm between the radiator and your body.

This transmitter must not be co-located or operating in conjunction with any other antenna or transmitter.

iChip, Nano Socket iWiFi, IP Communication Controller, SerialNET, AT+i and Connect One are trademarks of Connect One Ltd.

Copyright © 2008, 2009 Connect One Ltd. All rights reserved.

## Revision History

### 11-4300-08

Version	Date	Description
1.10	June 2009	Initial preliminary version
1.15	June 2009	Miscellaneous editing
1.20	July 2009	Updated resistor values for USB connector
1.25	July 2009	Updated Mechanical Dimensions
1.30	August 2009	Added Antenna Clearance Recommendation
1.31	August 2009	Added FCC certification information
1.35	September 2009	Updated mechanical dimensions

# Contents

<b>1</b>	<b>Introduction.....</b>	<b>1-1</b>
1.1	General Description .....	1-1
1.2	Hardware Description.....	1-1
1.3	Performance Specifications .....	1-1
<b>2</b>	<b>Features.....</b>	<b>2-1</b>
2.1	Security .....	2-1
2.2	Protocols .....	2-1
2.3	Additional Features .....	2-1
<b>3</b>	<b>Typical Applications .....</b>	<b>3-1</b>
<b>4</b>	<b>Connector Pin Description .....</b>	<b>4-1</b>
4.1	Pin Numbers.....	4-1
4.2	Pin Functional Description .....	4-2
4.2.1	Connector J8 .....	4-2
4.2.2	Connector J9 .....	4-2
<b>5</b>	<b>Interfaces.....</b>	<b>5-1</b>
5.1	Serial Interface .....	5-1
5.2	SPI Interface.....	5-1
5.3	USB Interface .....	5-1
5.4	RMII Interface.....	5-2
<b>6</b>	<b>Electrical Specifications .....</b>	<b>6-1</b>
6.1	Absolute Maximum Ratings .....	6-1
6.2	DC Operating Characteristics .....	6-1
6.3	AC Operating Characteristics.....	6-2
6.4	Tx Specifications .....	6-2
6.5	Rx Specifications.....	6-2
<b>7</b>	<b>On-Board Antenna .....</b>	<b>7-1</b>
<b>8</b>	<b>Mechanical Dimensions.....</b>	<b>8-2</b>
8.1	Antenna Clearance Recommendation .....	8-3

**9 Evaluation Board ..... 9-1**

**10 Ordering Information ..... 10-1**

**11 Internet Protocol Compliance ..... 11-1**

# Figures

Figure 3-4-1: Pin-out for Nano Socket iWiFi (Bottom View) ..... 4-1  
Figure 6-1: SPI Interface Waveforms ..... 6-2  
Figure 5-8-1: Mechanical Dimensions ..... 8-2

## Tables

Table 3-1: Connector Signal Description .....	4-2
Table 4-1: Absolute Maximum Ratings .....	6-1
Table 4-2: DC Operating Characteristics .....	6-1
Table 4-3: Tx Specifications .....	6-2
Table 4-4: Rx Specifications .....	6-2
Table 11-1: Internet Protocol Compliance .....	11-1

# 1 Introduction

## 1.1 General Description

Nano Socket iWiFi™ is a secure serial-to-Wireless LAN device-server module that also acts as a bridge to connect serial devices to 802.11b/g Wireless LANs. It includes the iChip™ CO2144 IP Communication Controller™ chip, Marvell 88W8686 WiFi chipset and an on-board antenna. It is packaged in a RoHS-compliant ultra-slim form factor and uses an industry standard pin-out.

Nano Socket iWiFi offers much more than many other device servers on the market. It acts as a security gap between the application and the network; supports up to 10 simultaneous TCP/UDP sockets; two listening sockets; a web server with two websites; SMTP and POP3 clients; MIME attachments; FTP and TELNET clients, and SerialNET™ mode for serial-to-IP bridging.

Nano Socket iWiFi supports the SSL3/TLS1 protocol for secure sockets, HTTPS and FTPS, WEP, WPA and WPA2 WiFi encryption.

Nano Socket iWiFi minimizes the need to redesign the host device hardware. It easily inserts into headers on the host PCB and includes an on-board antenna. Minimal or no software configuration is needed for Nano Socket iWiFi to access the Wireless LAN.

Connect One's high-level AT+i™ API eliminates the need to add WiFi drivers, security and networking protocols and tasks to the host application. The AT+i SerialNET operating mode offers a true plug-and-play mode that eliminates any changes to the host application.

Nano Socket iWiFi firmware – the IP stack and Internet configuration parameters – are stored in an on-board flash memory. The module is power-efficient: the core operates at 1.2V, while I/Os operate at 3.3V. Power Save mode further reduces power consumption.

The II-EVB-363MO evaluation board provides an easy environment for testing the Nano Socket iWiFi prior to designing it into your product.

## 1.2 Hardware Description

- Size: 45.21 x 24.88 x 8.6 mm
- Core CPU: Connect One CO2144, running at 48MHz
- Operating Voltage: +3.3V+/-10%
- Operating Humidity: 90% maximum (non-condensing)
- Operating Temperature Range: -20° to 75°C (-4° to 167°F)
- Power Consumption:
  - Transmit – 250mA @16dbm
  - 235mA @12dbm (typical)
  - Receive – 190mA (typical)
  - Power Save mode – 8mA
- On-Board 2dBi Antenna
- Connector: 2 x 15 Header 2mm pitch
- Host Interface: TTL Serial, SPI and USB device.
- RMI Interface
- RoHS-compliant; lead-free

## 1.3 Performance Specifications

- Host Data Rate: up to 3Mbps in serial mode, 12Mbps in LAN-WiFi mode
- Serial Data Format (AT+i mode): Asynchronous character; binary; 8 data bits; no parity; 1, 1.5 or 2 stop bits
- SerialNET mode: Asynchronous character; binary; 7 or 8 data bits; odd, even, or no parity; 1, 1.5 or 2 stop bits
- Flow Control: Hardware (-RTS, -CTS) and software flow control.



### Internet Protocols

ARP, ICMP, IP, UDP, TCP, DHCP, DNS, NTP, SMTP, POP3, MIME, HTTP, FTP and TELNET

### Security Protocols

SSL3/TLS1, HTTPS, FTPS, RSA, AES-128/256, 3DES, RC-4, SHA-1, MD-2, MD-5, WEP, WPA and WPA2 (PSK and Enterprise mode)

### Protocols Accelerated in HW

AES, 3DES and SHA

### Application Program Interface

Connect One's AT+i protocol

SerialNET mode for transparent serial data-to-Internet bridging

### Wireless Specifications

Standards Supported: IEEE 802.11b, IEEE 802.11b/g

- Frequency:
  - Europe – 2.412-2.472GHz
  - USA – 2.412-2.462GHz
- Channels:
  - Europe – 13 channels
  - USA – 11 channels

### Warranty

One year

### Certifications

#### • Radio and EMC:

- USA
  - o FCC Modular Approval, FCC ID: XM5-SM2144N2
  - o CFR Title 47 FCC Part 15, Subpart B and C
- Canada
  - o Industry Canada Module Approval, IC: 8516A-SM2144N2
  - o Industry Canada ICES-003, RSS-Gen, RSS-210
- EU
  - o EN 300 328 (R&TTE Directive 1999/5/EC)
  - o EN 301 489 (EMC Directive 2004/108/EC)

#### • Safety:

- o UL 60950
- o CAN/CSA-C22.2 No. 60950
- o EN 60950, Low Voltage Directive (2006/95/EC)

### Installation Requirements

The Nano Socket iWiFi must be installed within a full-enclosure device that is safety certified.

## 2 Features

### 2.1 Security

- Acts as a security gap between the host application and the network
- One secure SSL3/TLS1 socket
- Provides WEP, WPA / WPA2 (PSK and Enterprise mode) Wireless LAN security
- Supports multiple Certificate Authorities and both client-side and server-side authentication
- Secure FTP and HTTP clients (over SSL3)
- Secure HTTPS Server (over SSL3)
- Includes a true hardware random number generator
- AES, 3DES and SHA accelerated in hardware

### 2.2 Protocols

- Up to 10 simultaneous TCP/UDP sockets and two listening sockets
- HTTP and HTTPS client
- HTTP and HTTPS web server with two on-chip websites: configuration site and application site
- FTP, FTPS and TELNET clients
- DHCP client and server
- Sending and receiving textual email and binary email with MIME attachments

### 2.3 Additional Features

- Non-volatile, on-chip operational parameter database
- Supports infrastructure and ad-hoc Wireless LAN networks
- SerialNET mode for serial-to-IP bridging (port server mode)
- Local firmware update
- Remote configuration and firmware update over the Internet
- Retrieval of time data from a Network Time Server

**Note:** For a detailed description of all available features, see the *AT+i Programmer's Manual*.

### 3 Typical Applications

- Adding IP communications over WiFi to serial embedded devices.
- Replacing a LAN cable with a WiFi connection.
- Adding SSL security to M2M solutions.

#### **Nano Socket iWiFi supports several operation modes:**

- **LAN to WiFi Bridge** - allowing transparent bridging of LAN over WiFi, using direct RMI connection to existing MAC hardware or direct PHY-to-PHY connection.

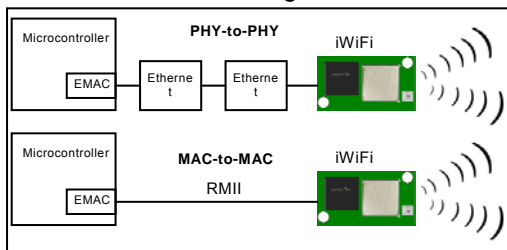

- **SerialNet™ Serial to WiFi Bridge** - allowing transparent bridging of Serial over WiFi, using a 3Mbps fast UART. This is a true plug-and-play mode that eliminates any changes to the host application.
- **PPP modem emulation** – allowing existing (i.e. modem) designs currently using PPP to connect transparently over WiFi.
- **Full Internet Controller mode** – allowing simple MCU to use the Nano Socket iWiFi's rich protocol and application capabilities to perform complex Internet operations such as E-mail, FTP, SSL, embedded Web server and others. It also acts as a firewall, providing a security gap between the application and the network.

## 4 Connector Pin Description

The Nano Socket iWiFi module includes the iChip CO2144 IP Communication Controller and the Marvell 88W8686 802.11b/g WiFi chipset mounted on a socket form-factor module.

### 4.1 Pin Numbers

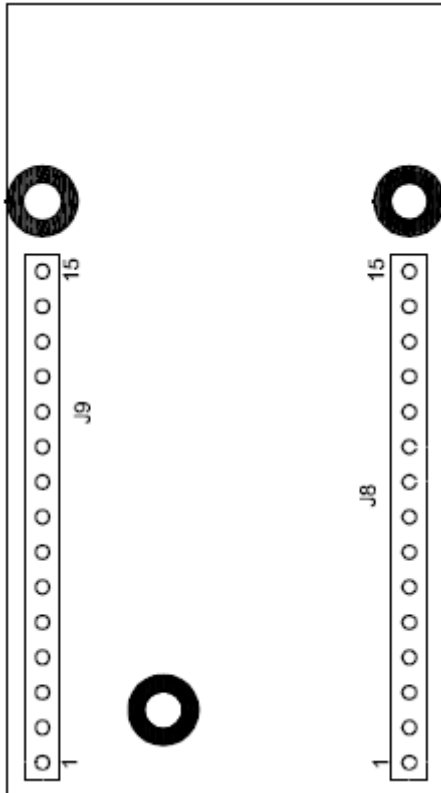

Figure 3-4-1: Pin-out for Nano Socket iWiFi (Bottom View)

Connector: 2 x 15pin Header Male 2mm pitch

Mate with: 2 x 15pin Header Female 2mm pitch:

Samtec	# SQT-115-01-F-S
Morethanall	# S-D63-1x15-LF
Weitronic	# 136-1510-10-10-60
or compatible.	

## 4.2 Pin Functional Description

### 4.2.1 Connector J8

Pin	Signal	type	Description
1	ERX0	Input	RMII Receive Data 0
2	ERX1	Input	RMII Receive Data 1
3	EMDC	Output	Management data Clock
4	ERXER	Input	RMII Receive Error
5	RMII_REFCLK	Input	RMII Reference Clock
6	GND	power	
7	V <sub>DD</sub>	Power	
8	RXD0	Input	UART 0 receive
9	TXD0	Output	UART 0 transmit
10	nCTS0	Input	UART 0 clear to send
11	nRTS0	Output	UART 0 request to send
12	DATA_RDY	Output	Data ready. High when data receive from Internet is buffered
13	MSEL	Input	Mode select. Rescue and Force F/W update pin
14	nRESET	Input	Reset Module. Pull LOW for 100mSec to Reset
15	nRF_LED	Output	RF LED indicator

### 4.2.2 Connector J9

Pin	Signal	type	Description
1	ETX0	Output	RMII transmit Data 0
2	ETX1	Output	RMII transmit Data 1
3	EMDIO	I/O	Management data I/O
4	CRSDV	Input	RMII Carrier sense and Data Valid
5	ETX_EN	Output	RMII Transmit Enable
6	nSPI1_CS	Input	SPI 1 chip select for host
7	SPI1_CLK	Input	SPI 1 clock for host (Max 12MHz)
8	SPI1_MISO	Output	SPI 1 slave out for host master in
9	SPI1_MOSI	Input	SPI 1 slave in for host master out
10	SPI1_INT	Output	SPI 1 have data on his buffer
11	Readiness	Output	High when iChip Ready for commands
12	DDM	Analog	USB device negative
13	DDP	Analog	USB device positive
14	N.C.		
15	GND	Power	

Table 3-1: Connector Signal Description

Note: Ethernet, UART, USB or SPI interfaces may be left unconnected if not used.

## 5 Interfaces

### 5.1 Serial Interface

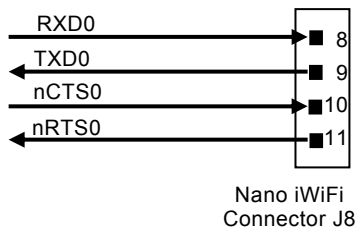

**Note:** If UART is not used leave TXD0 and RXD0 N.C. and short nCTS0 to nRTS0

### 5.2 SPI Interface

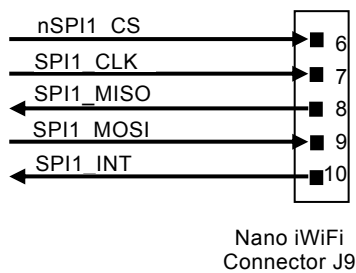

**Note:** If SPI is not used leave all signals N.C.

### 5.3 USB Interface

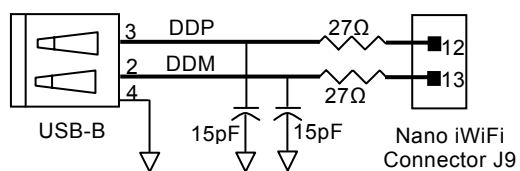

**Note:** If USB is not used leave all signals N.C.

## 5.4 RMII Interface

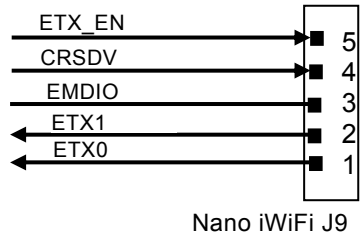
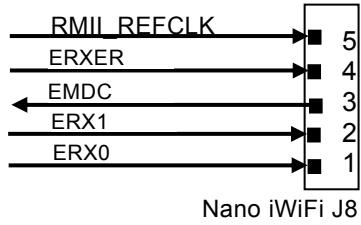

**Note:** If RMII is not used leave all signals N.C.

## 6 Electrical Specifications

### 6.1 Absolute Maximum Ratings

Parameter	Rating
Voltage at any pin with respect to ground	-0.3V to +3.6V
Operating temperature	-20°C to 75°C (-4°F to 167.5°F)
Storage temperature	-65°C to 125°C (-85°F to 257°F)

Table 4-1: Absolute Maximum Ratings

### 6.2 DC Operating Characteristics

Parameter	Min	Typical	Max	Units
VDD	3.0	3.3	3.6	Volts
High-level Input	2.0		VDD I/O+0.3	Volts
Low-level Input	-0.3		0.8	Volts
High-level Output @2mA	VDD I/O-0.4			Volts
High-level Output @0mA	VDD I/O-0.2			Volts
Low-level Output @2mA			0.4	Volts
Low-level Output @0mA			0.2	Volts
Input leakage current			10	µA
Power supply current from VDD (Transmit Mode)		260	280	mA
Power supply current from VDD (Receive Mode)		190	210	mA
Power supply current from VDD (Power Save Mode)		8*		mA
Input Capacitance			5.3	pF
Radio Frequency Range (subject to local regulation)	2.412		2.484	GHz

Table 4-2: DC Operating Characteristics

(\*) **Note:** Power supply current as measured in firmware version i2128d722B05.



## 6.3 AC Operating Characteristics

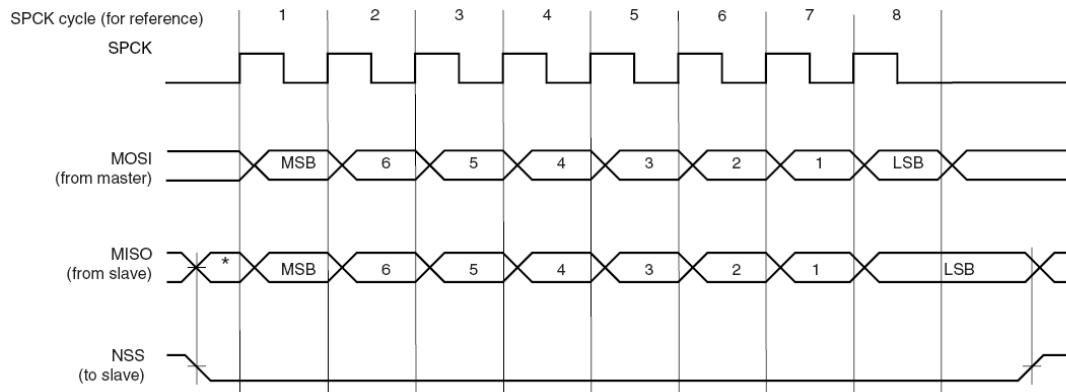

Figure 6-1: SPI Interface Waveforms

## 6.4 Tx Specifications

Item	Condition	Min	Typ	Max	Unit
Transmit Power Levels	11b		15		dBm
	11g		15		dBm
Transmit Spectrum Mask	11b	Fc+/-11MHz	40		dBc
		Fc+/-22MHz	60		dBc
	11g	Fc+/-11MHz	30		dBc
		Fc+/-20MHz	40		dBc
		Fc+/-30MHz	50		dBc
Transmit Center Frequency Tolerance	Temperature=25°C		±10		ppm

Table 4-3: Tx Specifications

## 6.5 Rx Specifications

Item	Condition	Min	Typ	Max	Unit
Receiver Minimum Input Level Sensitivity	802.11b Data Rate=11Mbps, PER<8%		-88		dBm
	802.11g Data Rate=54Mbps, PER<10%		-74		dBm
Adjacent Channel Rejection Desired channel is 3dB above sensitivity	802.11b Data Rate=11Mbps, PER<8%		48		dBc
	802.11g Data Rate=54Mbps, PER<10%		15		dBc

Table 4-4: Rx Specifications

$$PER(\%) = (\text{Number of all packets} - \text{Number of received packets}) / (\text{Number of all packets} \times 100)$$

## 7 On-Board Antenna

- Designed for 2.4Ghz operation
- Peak Gain: 2.1 dBi
- Average efficiency: 75%
- Max return loss: -11dBi
- Max VSWR: 1.8:1

Antenna Patterns:

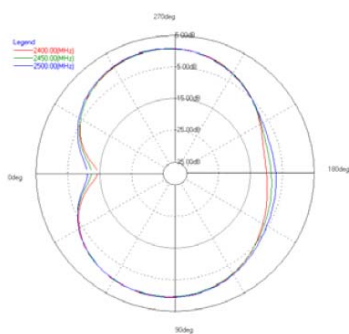
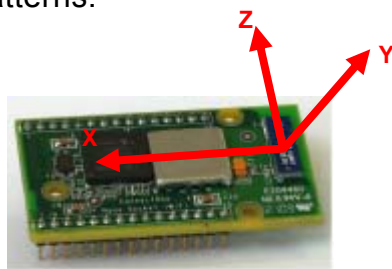

XY plane

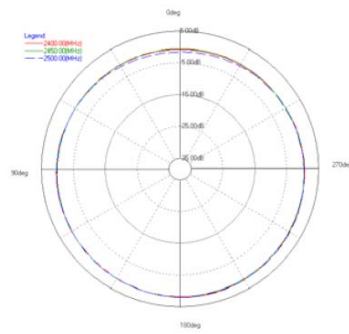

ZY plane

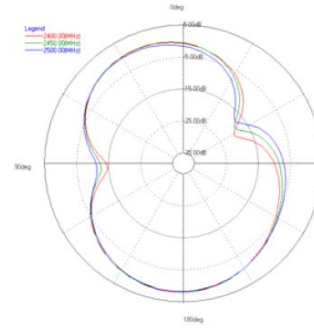

XZ plane

## 8 Mechanical Dimensions

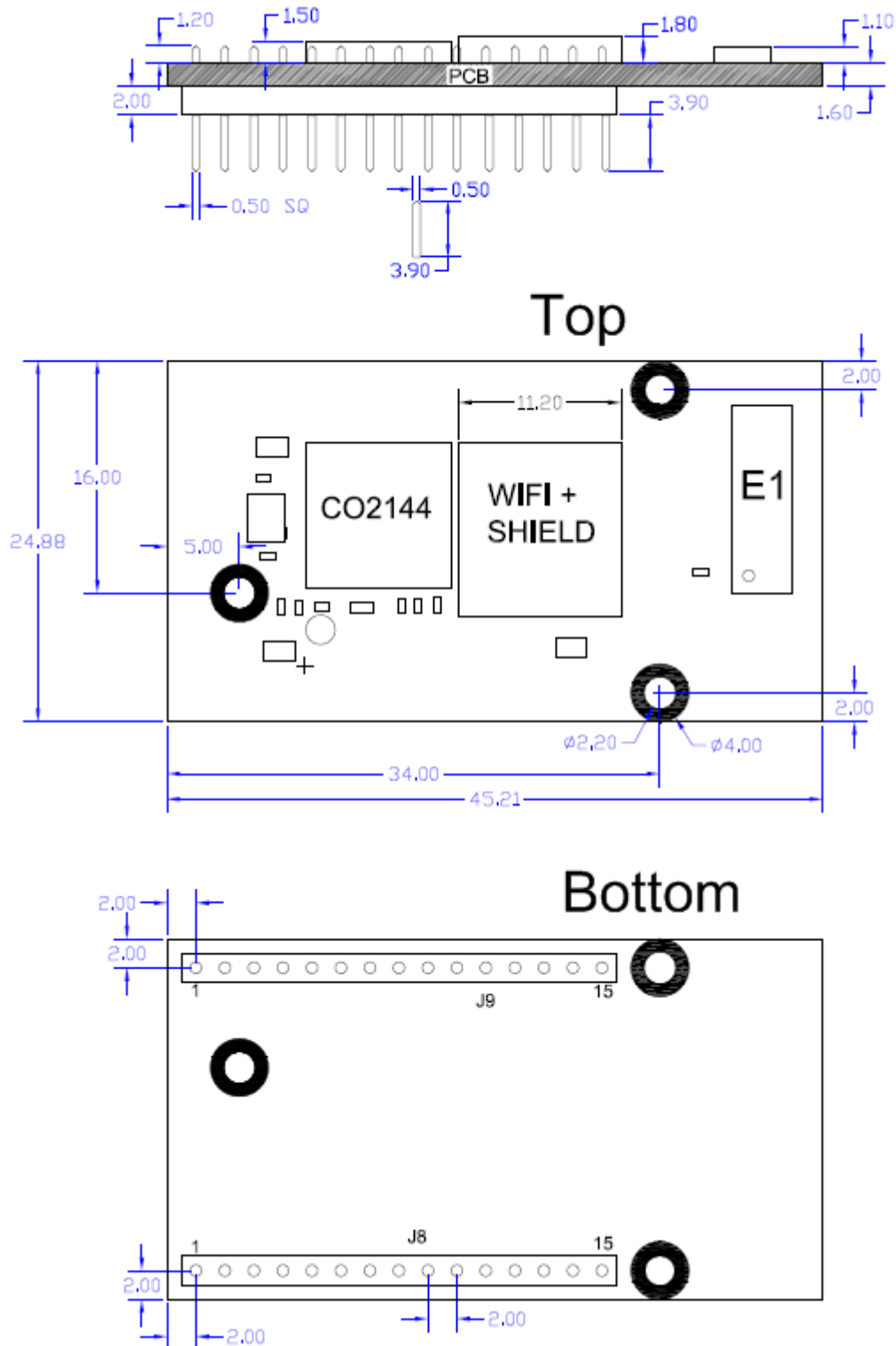
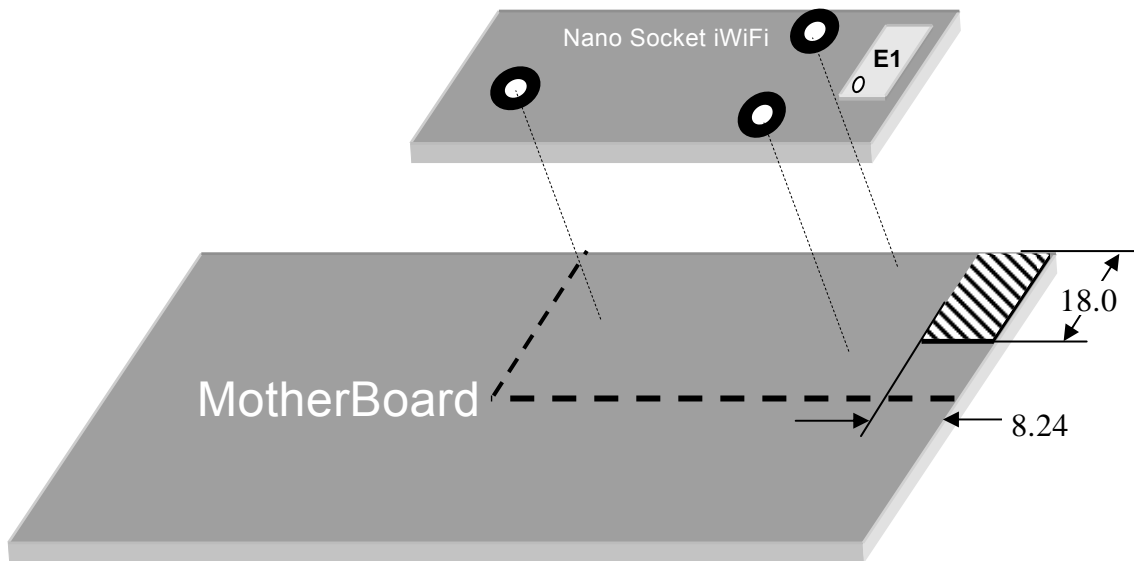

Figure 5-8-1: Mechanical Dimensions

**Note:** All measurements in millimeters. Tolerance: Length/Width  $\pm 0.15$ mm, PCB thickness  $\pm 10\%$ , Plated bores:  $\pm 0.075$ mm, Non-Plated bores: 0.05mm, Bore positions:  $\pm 0.1$ mm

## 8.1 Antenna Clearance Recommendation

Hatched area below should be clear of metal, ground planes and wiring.



## 9 Evaluation Board

The II-EVB-363-MO evaluation board enables you to evaluate the Nano Socket iWiFi without changing anything in your current development environment. Using a simple Windows-based application on a PC, you can issue AT+i commands to the iChip CO2144 and get responses. A full description of the board and user manuals are available on <http://www.connectone.com/products.asp?did=38&pid=99>

*Note: The evaluation board supports serial host data rates of up to 1Mbps.*

---

AT+i commands are used to configure parameter values into iChip's flash memory and activate Internet tasks such as email send, sockets, FTP sessions, configuration, and more.

A full description of AT+i commands can be found in the *AT+i Programmer's Manual* on Connect One's website at: <http://www.connectone.com/support.asp?did=35>

To help you evaluate the Nano Socket iWiFi, Connect One supplies the iChip Config Utility. This is a Windows-based application that contains intuitive dialog boxes to fully configure iChip CO2144. It doesn't require any knowledge of AT+i commands. It also contains local firmware update functionality. The iChip Config Utility allows you to perform specific Internet communication tasks such as sending and receiving emails, activating iChip's websites, entering SerialNET mode, and more. The latest iChip Config Utility version and user manual can be found on Connect One's website under the Support section.

On board connectors allow a choice of Host interfaces:

- RS232 COM port
- SPI
- USB

## 10 Ordering Information

Ordering Information	
Part Number	Description
iW-SM2144N2-US	Nano Socket iWiFi, for USA, onboard Antenna
iW-SM2144N2-EU	Nano Socket iWiFi, for Europe, onboard Antenna
II-EVB-363MO-US-110	Evaluation board for Nano Socket iWiFi, for USA, with 110V power supply
II-EVB-363MO-EU-220	Evaluation board for Nano Socket iWiFi, for Europe, with 220V power supply

# 11 Internet Protocol Compliance

Nano Socket iWiFi complies with the Internet standards listed in the following table.

<b>RFC 768</b>	User datagram protocol (UDP)
<b>RFC 791</b>	Internet protocol (IP)
<b>RFC 792</b>	ICMP – Internet control message protocol
<b>RFC 793</b>	Transmission control protocol (TCP)
<b>RFC 821</b>	Simple mail transfer protocol (SMTP)
<b>RFC 822</b>	Standard for the format of ARPA Internet text messages
<b>RFC 826</b>	Ethernet address resolution protocol (ARP)
<b>RFC 959</b>	File transfer protocol (FTP)
<b>RFC 854</b>	TELNET protocol specification
<b>RFC 857</b>	Telnet ECHO option
<b>RFC 858</b>	Telnet suppress go-ahead option
<b>RFC 1034</b>	Domain names (DNS) - concepts and facilities
<b>RFC 1035</b>	Domain names (DNS) - implementation and specification
<b>RFC 1073</b>	Telnet window size option
<b>RFC 1091</b>	Telnet terminal type option
<b>RFC 1321</b>	MD5 message digest algorithm
<b>RFC 1939</b>	Post office protocol - version 3 (POP3)
<b>RFC 1957</b>	Some observations on the implementations of the post office protocol (POP3)
<b>RFC 2030</b>	Simple network time protocol (SNTP)
<b>RFC 2045</b>	Multipurpose Internet mail extensions (MIME) part one: internet message body format
<b>RFC 2046</b>	MIME part two: media types
<b>RFC 2047</b>	MIME part three: message header extensions for non-ASCII text
<b>RFC 2048</b>	MIME part four: registration procedures
<b>RFC 2049</b>	MIME part five: conformance criteria and examples
<b>RFC 2068</b>	Hypertext transfer protocol HTTP/1.1
<b>RFC 2131</b>	Dynamic host configuration protocol (DHCP)
<b>RFC 2132</b>	DHCP options (only relevant parts)
<b>RFC 2228</b>	FTP security extensions
<b>RFC 2246</b>	The TLS protocol version 1.0

*Table 11-1: Internet Protocol Compliance*

# Mouser Electronics

Authorized Distributor

Click to View Pricing, Inventory, Delivery & Lifecycle Information:

[Connect One:](#)

[iW-SM2144N2-US](#) [iW-SM2144N2-EU](#)